

# Kenai Construction Permitting

## Kenai 1st Quarter Permit Values by Type - 1999-2005 - in \$

	1999	2000	2001	2002	2003	2004	2005	Annual Change
Residential - New	0	228,000	623,000	279,000	0	300,000	0	NA
Residential - Add/Alter	122,000	7,000	161,500	28,000	15,000	12,000	134,500	1020.8%
Commercial - New	14,500	65,000	15,000	3,579,200	0	0	0	NA
Commercial - Add/Alter	103,000	162,900	20,000	2,000	1,542,600	0	291,000	NA
TOTAL	239,500	462,900	819,500	3,888,200	1,557,600	312,000	425,500	36.4%
Annual Change		93.3%	77.0%	374.5%	-59.9%	-80.0%	36.4%	

Table 3.7

## Kenai 1st Quarter Permit Values by Type - 1986-2005

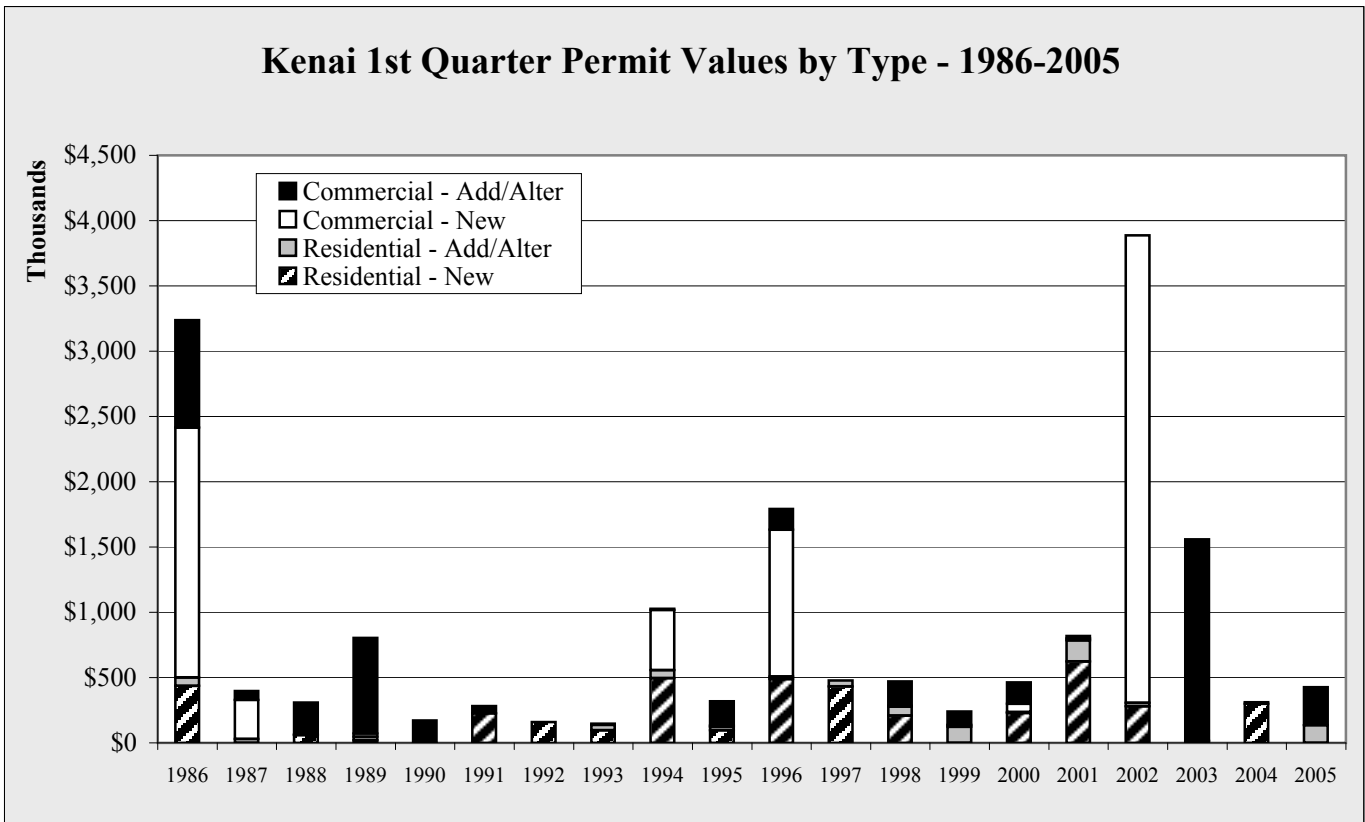

Chart 3.9

## Kenai 1st Quarter Permit Value Percent by Type - 2005

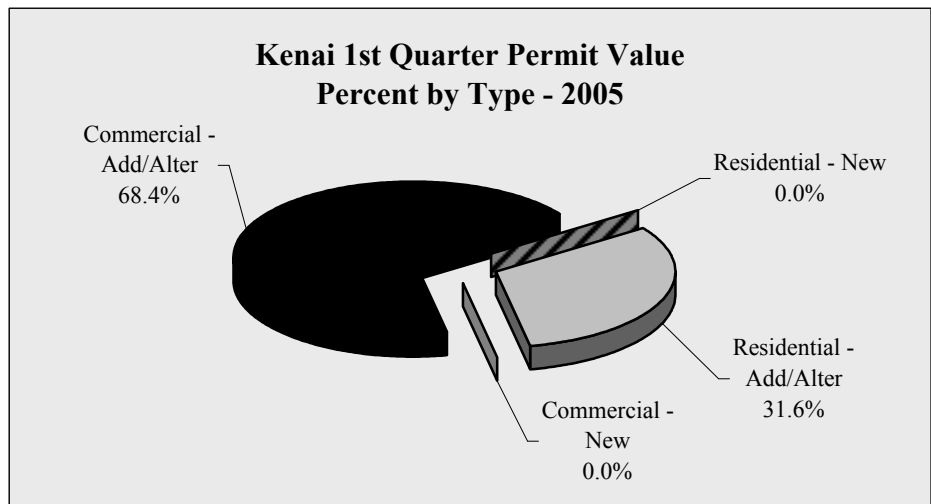

Chart 3.10

# Kenai Construction Permitting

## Kenai 1st Quarter Permit Volume by Type - 1999-2005

	1999	2000	2001	2002	2003	2004	2005	Annual Change
Residential - New	3	2	5	1	1	1	0	-100.0%
Residential - Add/Alter	1	1	1	1	0	0	7	NA
Commercial - New	3	4	1	1	7	0	0	NA
Commercial - Add/Alter	7	8	11	5	8	4	3	-25.0%
TOTAL	14	15	18	8	16	5	10	100.0%
Annual Change		7.1%	20.0%	-55.6%	100.0%	-68.8%	100.0%	

Table 3.8

## Kenai 1st Quarter Permit Volume by Type - 1986-2005

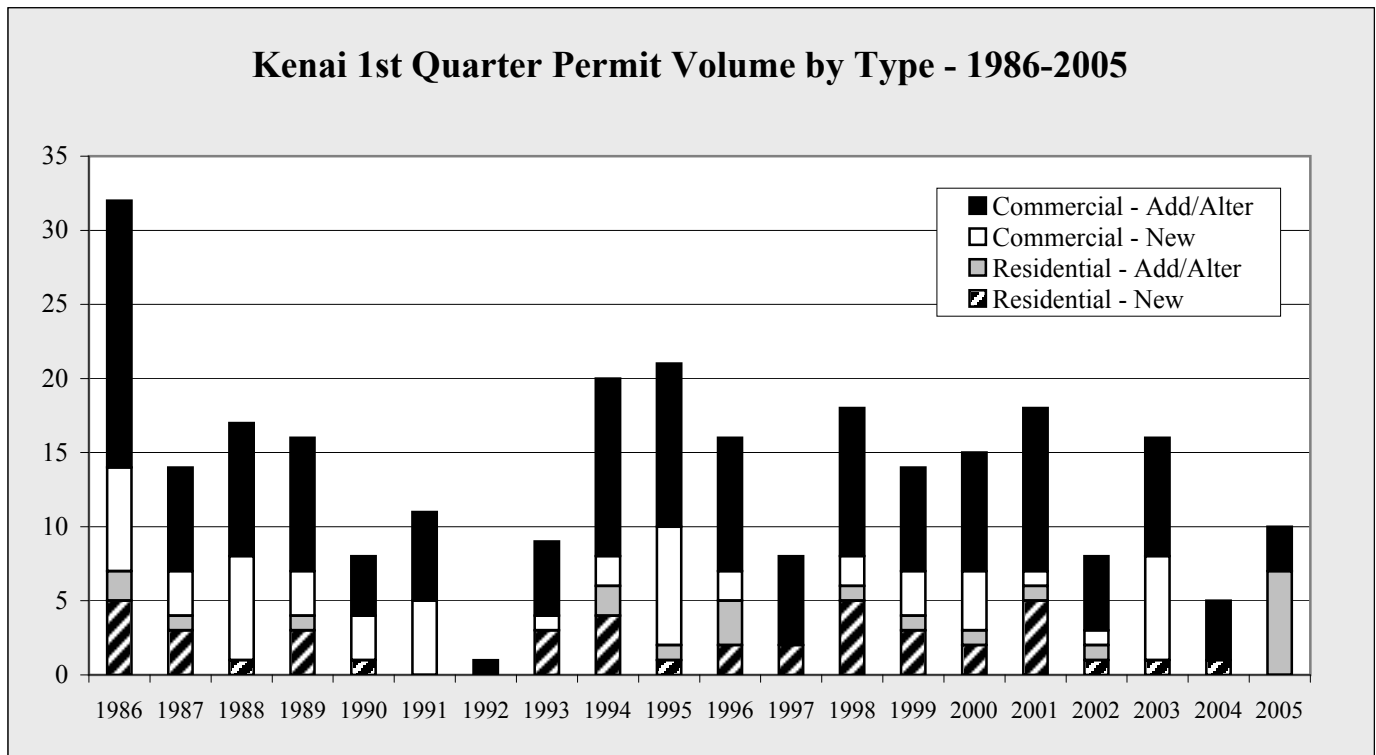

Chart 3.11

## Kenai 1st Quarter Permit Volume Percent by Type - 2005

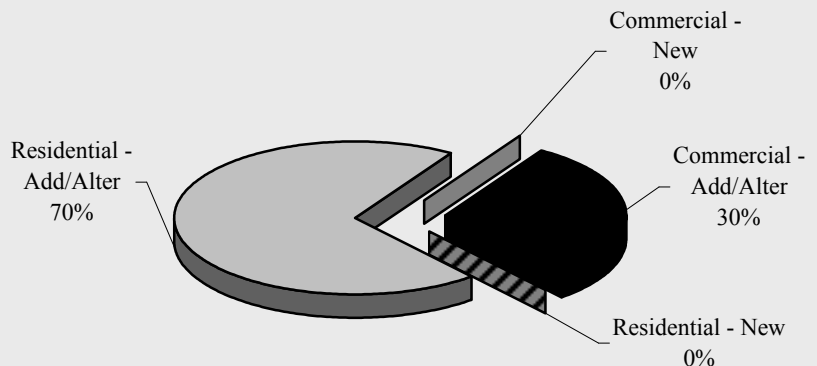

Chart 3.12

# Kenai Construction Permitting

Kenai Annual Permit Values by Type - 1998-2004 - in \$

	1998	1999	2000	2001	2002	2003	2004	Annual Change
Residential - New	6,033,500	3,324,000	3,497,000	4,985,000	5,917,000	3,282,000	3,058,500	-6.8%
Residential - Add/Alter	730,700	798,000	888,400	675,100	723,500	882,050	400,150	-54.6%
Commercial - New	151,000	4,797,750	4,250,000	5,379,700	6,261,200	304,000	331,000	8.9%
Commercial - Add/Alter	727,000	522,000	762,700	2,539,100	3,897,700	5,973,750	996,900	-83.3%
TOTAL	7,642,200	9,441,750	9,398,100	13,578,900	16,799,400	10,441,800	4,786,550	-54.2%
Annual Change		23.5%	-0.5%	44.5%	23.7%	-37.8%	-54.2%	

Table 3.9

Kenai Annual Permit Values by Type - 1986-2004

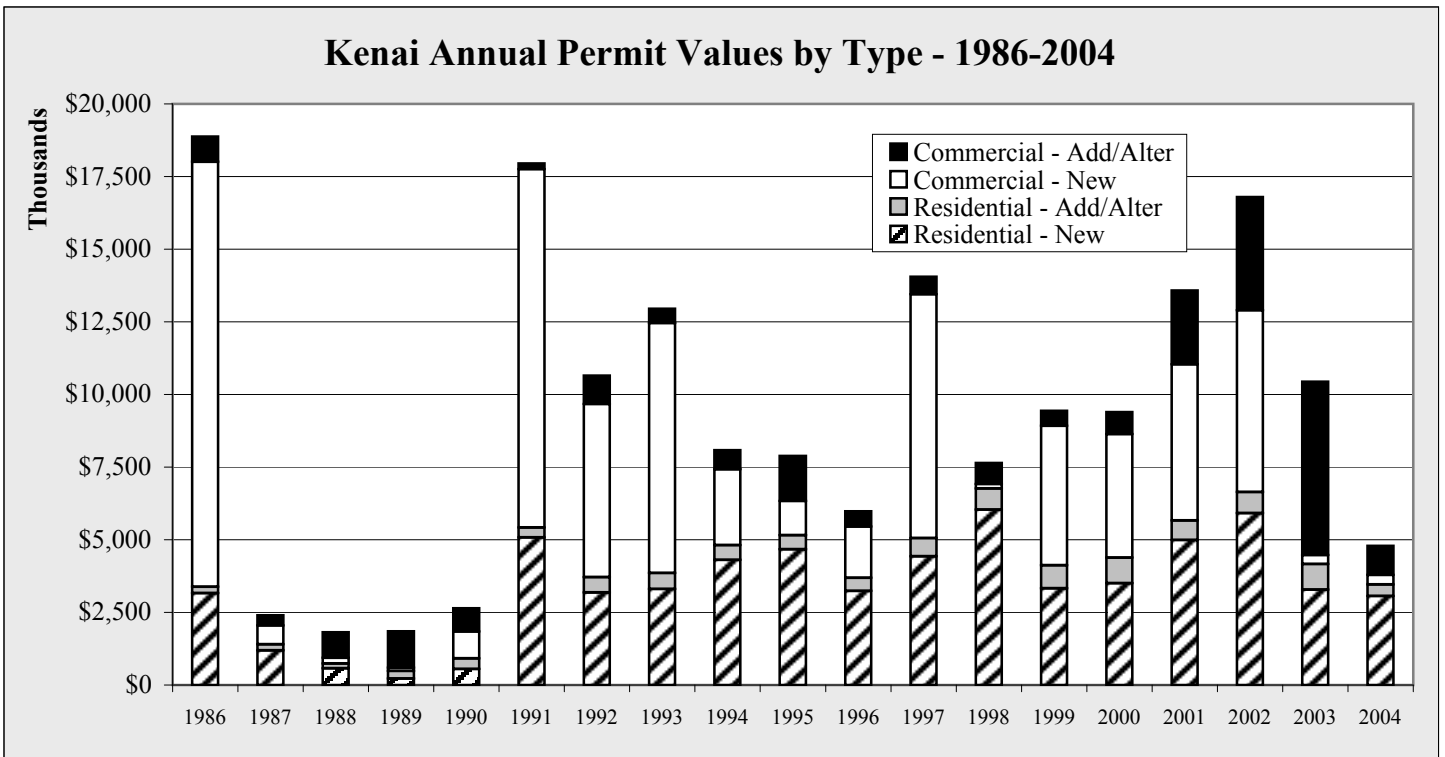

Chart 3.13

Kenai Annual Permit Values  
Percent by Type - 2004

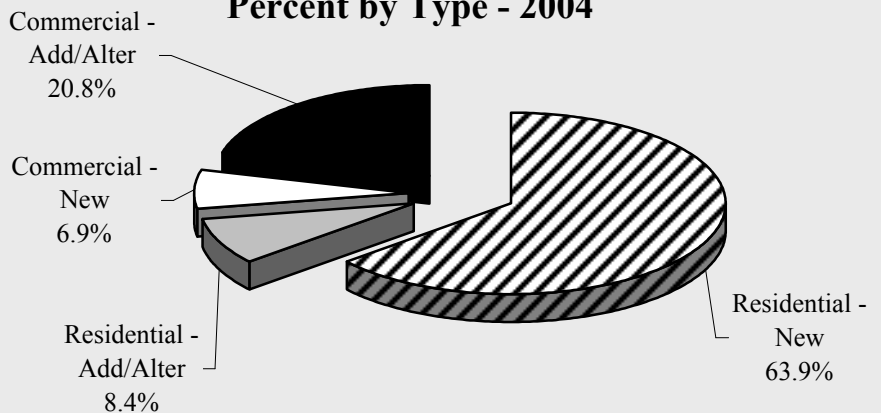

Chart 3.14

# Kenai Construction Permitting

Kenai Annual Permit Volume by Type - 1998-2004

	1998	1999	2000	2001	2002	2003	2004	Annual Change
Residential - New	45	26	26	30	42	22	20	-9.1%
Residential - Add/Alter	33	41	45	31	45	44	25	-43.2%
Commercial - New	4	13	11	8	9	4	3	-25.0%
Commercial - Add/Alter	15	22	11	18	25	44	31	-29.5%
TOTAL	97	102	93	87	121	114	79	-30.7%
Annual Change		5.2%	-8.8%	-6.5%	39.1%	-5.8%	-30.7%	

Table 3.10

Kenai Annual Permit Volume by Type - 1986-2004

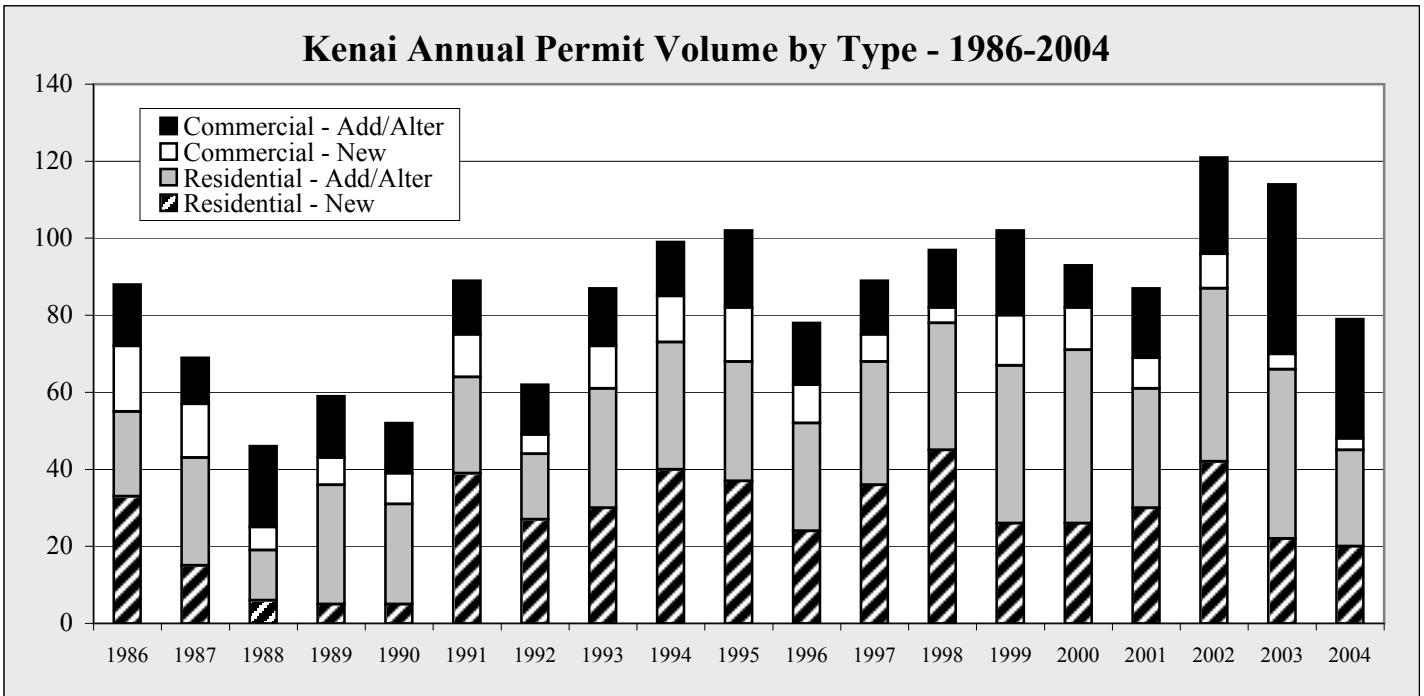

Chart 3.15

Kenai Annual Permit Volume Percent by Type - 2004

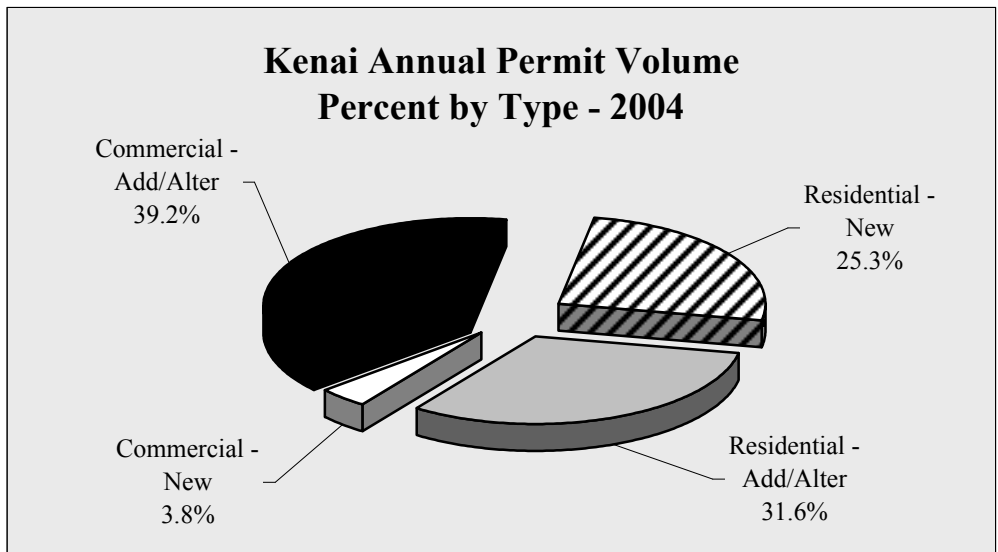

Chart 3.16

# Kenai Construction Permitting

## Kenai Permit Values by Quarter by Type - 1998-2005 - in \$

	1st Quarter	2nd Quarter	3rd Quarter	4th Quarter	Total
<b>1998</b>					
Residential - New	208,500	3,884,500	1,524,500	416,000	6,033,500
Residential - Add/Alter	68,500	495,500	122,900	43,800	730,700
Commercial - New	7,000	0	95,000	49,000	151,000
Commercial - Add/Alter	186,500	21,500	432,500	86,500	727,000
<b>TOTAL</b>	<b>470,500</b>	<b>4,401,500</b>	<b>2,174,900</b>	<b>595,300</b>	<b>7,642,200</b>
<b>1999</b>					
Residential - New	0	1,573,000	1,049,000	702,000	3,324,000
Residential - Add/Alter	122,000	187,600	267,000	221,400	798,000
Commercial - New	14,500	61,000	4,597,250	125,000	4,797,750
Commercial - Add/Alter	103,000	201,000	209,400	8,600	522,000
<b>TOTAL</b>	<b>239,500</b>	<b>2,022,600</b>	<b>6,122,650</b>	<b>1,057,000</b>	<b>9,441,750</b>
<b>2000</b>					
Residential - New	228,000	1,606,000	1,287,000	376,000	3,497,000
Residential - Add/Alter	7,000	439,000	387,000	55,400	888,400
Commercial - New	65,000	1,045,000	2,896,000	244,000	4,250,000
Commercial - Add/Alter	162,900	73,000	524,000	2,800	762,700
<b>TOTAL</b>	<b>462,900</b>	<b>3,163,000</b>	<b>5,094,000</b>	<b>678,200</b>	<b>9,398,100</b>
<b>2001</b>					
Residential - New	623,000	2,886,000	1,152,000	324,000	4,985,000
Residential Add/Alter	161,500	228,300	217,500	67,800	675,100
Commercial - New	15,000	3,744,000	1,406,700	214,000	5,379,700
Commercial - Add/Alter	20,000	739,600	1,730,000	49,500	2,539,100
<b>TOTAL</b>	<b>819,500</b>	<b>7,597,900</b>	<b>4,506,200</b>	<b>655,300</b>	<b>13,578,900</b>
<b>2002</b>					
Residential - New	279,000	2,362,000	2,899,000	377,000	5,917,000
Residential Add/Alter	28,000	323,100	302,400	70,000	723,500
Commercial - New	3,579,200	1,480,000	212,000	990,000	6,261,200
Commercial - Add/Alter	2,000	404,300	3,400,600	90,800	3,897,700
<b>TOTAL</b>	<b>3,888,200</b>	<b>4,569,400</b>	<b>6,814,000</b>	<b>1,527,800</b>	<b>16,799,400</b>
<b>2003</b>					
Residential - New	0	1,943,000	560,000	779,000	3,282,000
Residential Add/Alter	15,000	515,200	168,850	183,000	882,050
Commercial - New	0	0	51,000	253,000	304,000
Commercial - Add/Alter	1,542,600	270,150	2,920,500	1,240,500	5,973,750
<b>TOTAL</b>	<b>1,557,600</b>	<b>2,728,350</b>	<b>3,700,350</b>	<b>2,455,500</b>	<b>10,441,800</b>
<b>2004</b>					
Residential - New	300,000	1,079,000	1,197,500	482,000	3,058,500
Residential Add/Alter	12,000	52,200	308,950	27,000	400,150
Commercial - New	0	81,000	250,000	0	331,000
Commercial - Add/Alter	0	685,200	235,300	76,400	996,900
<b>TOTAL</b>	<b>312,000</b>	<b>1,897,400</b>	<b>1,991,750</b>	<b>585,400</b>	<b>4,786,550</b>
<b>2005</b>					
					<b>Year to Date</b>
Residential - New	0				0
Residential Add/Alter	134,500				134,500
Commercial - New	0				0
Commercial - Add/Alter	291,000				291,000
<b>TOTAL</b>	<b>425,500</b>				<b>425,500</b>

Table 3.11

# Kenai Construction Permitting

## Kenai Permit Volume by Quarter by Type - 1998-2005

	1st Quarter	2nd Quarter	3rd Quarter	4th Quarter	Total
<b>1998</b>					
Residential - New	2	27	13	3	45
Residential - Add/Alter	5	10	13	5	33
Commercial - New	1	0	1	2	4
Commercial - Add/Alter	2	2	3	8	15
<b>TOTAL</b>	<b>10</b>	<b>39</b>	<b>30</b>	<b>18</b>	<b>97</b>
<b>1999</b>					
Residential - New	0	12	7	7	26
Residential - Add/Alter	3	13	12	13	41
Commercial - New	1	1	10	1	13
Commercial - Add/Alter	3	7	11	1	22
<b>TOTAL</b>	<b>7</b>	<b>33</b>	<b>40</b>	<b>22</b>	<b>102</b>
<b>2000</b>					
Residential - New	1	11	11	3	26
Residential - Add/Alter	2	18	18	7	45
Commercial - New	1	4	4	2	11
Commercial - Add/Alter	4	3	3	1	11
<b>TOTAL</b>	<b>8</b>	<b>36</b>	<b>36</b>	<b>13</b>	<b>93</b>
<b>2001</b>					
Residential - New	4	16	8	2	30
Residential Add/Alter	5	13	8	5	31
Commercial - New	1	3	3	1	8
Commercial - Add/Alter	1	10	4	3	18
<b>TOTAL</b>	<b>11</b>	<b>42</b>	<b>23</b>	<b>11</b>	<b>87</b>
<b>2002</b>					
Residential - New	2	18	19	3	42
Residential Add/Alter	1	14	26	4	45
Commercial - New	1	3	2	3	9
Commercial - Add/Alter	1	2	12	10	25
<b>TOTAL</b>	<b>5</b>	<b>37</b>	<b>59</b>	<b>20</b>	<b>121</b>
<b>2003</b>					
Residential - New	0	13	3	6	22
Residential Add/Alter	1	16	22	5	44
Commercial - New	0	0	2	2	4
Commercial - Add/Alter	7	11	18	8	44
<b>TOTAL</b>	<b>8</b>	<b>40</b>	<b>45</b>	<b>21</b>	<b>114</b>
<b>2004</b>					
Residential - New	3	5	8	4	20
Residential Add/Alter	1	8	12	4	25
Commercial - New	0	2	1	0	3
Commercial - Add/Alter	0	15	10	6	31
<b>TOTAL</b>	<b>4</b>	<b>30</b>	<b>31</b>	<b>14</b>	<b>79</b>
<b>2005 Year to Date</b>					
Residential - New	0				0
Residential Add/Alter	7				7
Commercial - New	0				0
Commercial - Add/Alter	3				3
<b>TOTAL</b>	<b>10</b>	<b>0</b>	<b>0</b>	<b>0</b>	<b>10</b>

Table 3.12